

**A STUDY ON DYNAMIC BEHAVIOR OF NATURAL
DRAFT COOLING TOWER CONSIDERING THE EFFECT
OF SOIL-STRUCTURE INTERACTION**

Mahesh Kumar CHITRAHALLI LINGARAJU¹, Shwetha KOTAGI GIRISHA²,
Shanthappa BHAKTANAKATTE CHANNABASAPPA³,
Manjunatha KARIGOWDA⁴

¹Research Scholar, Department of Civil Engineering, VTU-RRC, Belagavi, Karnataka,
India

^{1,2}Assistant Professor, Department of Civil Engineering, Nitte Meenakshi Institute of
Technology, Yelahanka, Bengaluru, Karnataka, India

³Principal, SJM Institute of Technology, Chitradurga, Karnataka, India

⁴Professor, UBDT College of Engineering, Davangere, Karnataka, India

Abstract

In this present era, the technology in advanced construction has developed to a very large extent. Some parts of the constructions are still in the improving stage which includes Cooling tower Construction. Hyperbolic cooling towers are large, thin shell reinforced concrete structures which Contribute to power generation efficiency, reliability, and to environmental protection. Cooling towers use evaporation of water to eject heat from processes such as cooling the circulating water used in oil refineries and in power plants. Nowadays in many thermal power plants, we can see the Cooling tower. So, preserving this industrial structure is an effort to save the cooling tower from dangerous earthquakes. The present-day cooling towers are exceptional structures in view of their sheer size and complexities. Present paper deals with the study of dynamic response that is modal analysis, seismic analysis of the two different cooling towers varying the H/t ratio and

¹ Corresponding author: Mahesh Kumar C L, Research Scholar, Department of Civil Engineering, VTU-RRC, Belagavi, Karnataka, India, Maheshkumar.cl@nmit.ac.in, 8548966564

thicknesses with fixity at the base boundary condition, and the soil is modelled as raft for the effect of soil-structure interaction using the direct approach. In this paper, hyperbolic cooling towers are modelled using Ansys software, which is a Finite element Software. Results show that the soil-structure interaction effect significantly modifies the earthquake behavior of Hyperbolic Cooling towers.

Keywords: hyperbolic cooling tower, richter scale, dynamic response, natural frequency, maximum principal stress

1. INTRODUCTION

India is the fifth largest power producer in the world from the recent census took place in 2017-18. we come across about 65% of the power contributed from the thermal power stations. In Karnataka six thermal power stations are established and their per-capita production is 5975.91 MW. Nowadays in many thermal power plants, we can see the Cooling tower. So preserving this Structure is an effort to save the Cooling tower from a dangerous earthquake. A slight intensity earthquake measuring 3.9 on the Richter Scale hit Dakshin Kannada region of Karnataka, but the atmospheric and environmental changes which need every structure either in and out of Karnataka should go for seismic analysis and for important structures like thermal power stations, in that we come across different segments one of the major segment or part is the “COOLING TOWER”.

A cooling tower is a structure used to reduce the temperature of a water stream by extracting heat from water and emitting it to the atmosphere. Cooling towers can lower the water temperatures more than devices that use only air to eject heat, like the radiator in a car and are therefore more cost-effective and energy-efficient. Hyperbolic cooling towers are enormous, slight shell strengthened solid structures which Add to control age proficiency, unwavering quality, and to natural security. A Natural draft cooling tower is an enclosed device where hot water gets cooled under direct contact with air. Natural draft cooling towers rank among the largest reinforced concrete thin shell structures. The cooling tower is designed by the engineer as more slender and thinner for the purpose of increasing the dead load [1]. The higher strength, durability, and large area available at base are the reasons that the hyperbolic shape of NDCT [2]. Natural draft cooling towers are present in many thermal and nuclear power stations. The slenderness of the columns and the large dimensions of the shell make these structures vulnerable to earthquake and wind disturbances [3].The thin outer shell of the tall natural draft cooling tower can be said to be the greatest structural innovation [4].

The present-day Natural draft cooling towers are exceptional structures in view of their sheer size and complexities [5]. It takes a shot at the rule of temperature contrast between the air inside and outside the peak. Hyperbolic state of the cooling tower is generally favoured because of its quality and soundness and

bigger accessible territory at the base [4]. Hyperbolic fortified solid cooling towers are viably utilized for cooling enormous amounts of water in thermal power stations, treatment facilities, nuclear power plants, steel plants, cooling, and other mechanical plants. Hyperbolic cooling tower also called a Natural draft cooling tower (NDCT) is the describing milestones of intensity stations and are utilized as heat exchangers in Thermal power plants. They contribute both to a good yield and to a cautious offset to site condition. The hyperbolic cooling tower is very important and essential component in thermal and nuclear power plants [6]. These shell structures are exposed to ecological loads, for example, Seismic and warm slopes that are stochastic in nature.

Busch et al. [7] demonstrated the optimization of a 200 m height natural draught cooling tower by varying the height of throat and inclination of meridian in reducing the stress due to wind load. Chiranjit Mishra et. Al [8] presented that in a series of wind tunnel tests, the wind-induced stresses in cooling towers situated in an arrangement of typical power plant buildings, are investigated and compared to the stresses in an isolated tower. Also Cooling tower response is governed by both vertical and circumferential wind distribution [9]. G. Murali et al. [10] examined two cooling towers with 122m and 200 m height. They studied the behaviour of these towers under the wind effect. They applied the wind load to the structures angularly and compared the values obtained as a result of the analysis. It was shown that the values of the bending moment and membrane force were different for three towers. G. Augusti et.al [11] have done simulations on nonlinear dynamic response of natural draught cooling towers to wind loading and carried out some investigations on checking the performance and reliability of the model. Li Long-yuan et.al [12] studied analysis of cooling tower shell with discrete fixed support and under the action of wind loads. The influences of ring-stiffener on cooling tower are discussed.

Different four-tower arrangements have a great impact on the wind-induced response and stability performance of the super-large cooling tower. However, a single indicator cannot provide a comprehensive and objective evaluation of the wind-resistance safety of cooling towers [15]. Wind tunnel experiments [13] were conducted under simulated terrain category 2 for evaluating interference factors using pressure models on four sets of cooling tower models, each when located in tandem. The tower corresponding to 165 m height had a geometric scale of 1:500 and the rest of the models corresponded to 1:300 scale [16]. The present paper focuses on the investigation of the dynamic study of hyperbolic cooling towers. The existing cooling towers dimensions are taken for study [16] and the Soil-Structure interaction study is done for hyperboloid structures such as cooling towers.

Because of the collapse of ferrybridge Cooling Towers in UK led to many intensive research on cooling towers [12]. The Present Paper manages the

investigation of static and dynamic examination of hyperbolic cooling towers with fixed base and soil-structure interaction effect. The existing cooling towers dimensions are taken from the following plants Pingwei phase II project, Haishen power station in Wuhai, and the Power station in Shouguang , Shandong province [15]. The boundary conditions considered are Top-end free and Bottom end is fixed and also the soil is modelled using the direct approach. Due to the high demand in the modern construction technology the design and the construction practices and technology towers with minimum thickness is preferred [17].

2. MODELLING

2.1. Description and Geometry of Cooling Towers

The Total Height of Cooling Tower-1 (CT1) is 80m. The tower has base, throat, and top radii of 28.95 m,17.2 m, and 17.9 m respectively, with throat located at 64 m from the base, with varying thicknesses of 200mm,300mm, and 500mm.

The Total Height of Cooling Tower-2(CT2) is 190m. The tower has base, throat, and top radii of 65.25 m, 42 m, and 43.45 m respectively, with the throat located at 119m from the base, with varying thicknesses of 200mm,300mm, and 500mm.

The geometry of the Hyperboloid revolution is

$$\frac{R_o^2}{a_o^2} - \frac{Y^2}{b^2} = 1 \quad (2.1)$$

where R_o is the horizontal radius at any vertical coordinate, Y with the origin of coordinates being defined by the center of the tower throat, a_o is the radius of the throat, and b is some characteristic dimension of the hyperboloid.

Table 1. Geometrical Description of CT1, CT2

Sl no	Description	Symbols	Parametric Values	
			CT1 in (m)	CT2 in (m)
1	Total height	H	80	190
2	Height of throat	H_{thr}	64	142.5
3	Diameter at top	D_t	35.8	86.9
4	Diameter at bottom	D_b	57.9	130.5
5	Diameter at throat level	D_{thr}	34.4	84

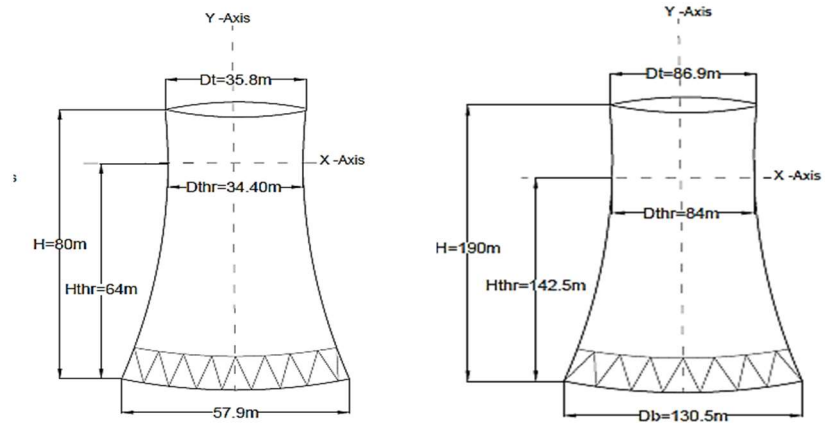

Fig. 1. Profile of typical CT1 and CT2

2.2. Modelling Tool

To develop a Cooling Tower Model for the present study, ANSYS Mechanical APDL 19.0 is used which is highly recommended Finite Element Software. ANSYS might be a broadly useful PC code, acclimated simulated collaborations of all controls of structural, physics, vibrations, heat transfer, fluid dynamics, and magnetism for engineers. So ANSYS, which permits simulating tests or working conditions, permits checking in virtual surroundings before delivering models of the product. In addition, determinative, and up powerless points, figuring life, and predicting likely issues square measure potential by 3D simulations in virtual surroundings. ANSYS Mechanical APDL 19.0 – a Finite Element tool, is currently used in this study.

3. RESULTS AND DISCUSSIONS

In Uttar Pradesh, Natural Draft Cooling Towers are less. Hence, in this research two Models of Natural Draft Cooling Towers are to be modeled using Ansys FEM package. Models are analyzed for seismic loads and Results are predicted in terms of Time period, Lateral Displacement, Principal stresses for Zone-IV [4].

Here two distinct models of Natural Draft Cooling Tower are made namely MODEL I - Natural Draft Cooling Tower with 80m Height.

MODEL II - Natural Draft Cooling Tower with 190m Height.

For the generation of the Design Spectra, the following factors are considered.

Zone factor: For Zone IV, $Z=0.24$ [18]

Importance factor, $I=1.50$

Response reduction factor, $R = 3.00$

Average response acceleration coefficient S_a/g =Soft soil site condition

Young's modulus=27.3Gpa

Poisson's Ratio=0.2

Density of RCC=25kN/m³

3.1. FEM Analysis Results

The Cooling Towers Modelling is done using 4 noded SHELL 181 for shell elements, Using ANSYS 19.0 software. Response spectrum analysis is carried out in the present study. The modelling may be used in seismic response analysis of cooling towers for obtaining detail stress distribution in the vulnerable shell-column region.[14]

For the generation of the Design Spectra, the maximum considered earthquake (MCE) is considered, hence the factor 2 in the denominator of equation 5.1[20] is not considered for the generation of response spectra and only the following factors are considered.

Table 2. Design Spectrum for seismic zone IV

TIME PERIOD, sec	Frequency, Hz	X And Z direction	Y direction
5	0.20	0.025	0.017
4	0.25	0.025	0.017
3	0.33	0.033	0.022
2	0.50	0.050	0.033
1	1.00	0.100	0.067
0.75	1.33	0.134	0.089
0.65	1.54	0.150	0.100
0.6	1.67	0.150	0.100
0.1	10.00	0.150	0.100
0.09	11.11	0.141	0.094
0.08	12.50	0.132	0.088
0.07	14.29	0.123	0.082
0.06	16.67	0.114	0.076
0.05	20.00	0.105	0.070
0.04	25.00	0.096	0.064
0.03	33.33	0.087	0.058
0.025	40.00	0.083	0.055
0.02	50.00	0.078	0.052

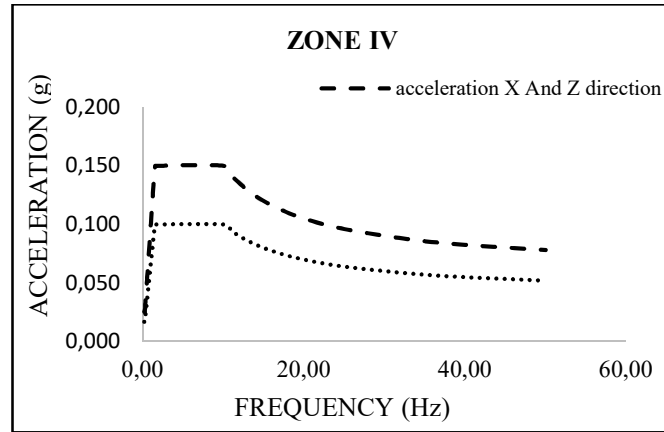

Fig. 2. Design Spectrum graph for seismic zone IV

3.2. Modal analysis results

As the thickness of the cooling tower increases for model's Natural frequency also increases. Model-1 with a fixed base is having a natural frequency of 1.847Hz whereas Model-1 with SSI is having 0.918Hz. This is because of the relative stiffness of soil.

Table 3. Modal analysis results for varying thickness

Model	H/t Ratio	Thickness (mm)	Natural frequency (Hz)	
			Fixed Boundary Condition	Soil Structure Interaction
CT-1	400	200	1.847	0.918
CT-1	300	267	1.923	0.843
CT-1	200	400	2.025	0.814
CT-2	400	475	0.579	0.355
CT-2	300	634	0.621	0.334
CT-2	200	950	0.617	0.312

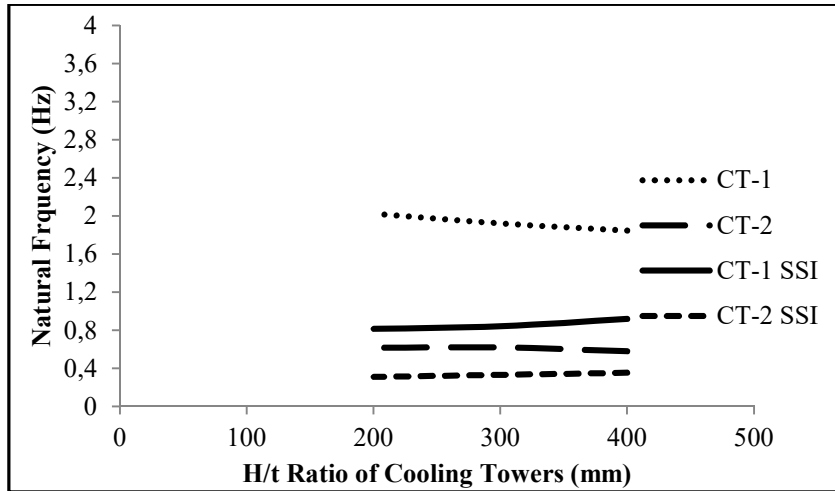

Fig. 3. H/t Ratio versus Natural Frequency Graph

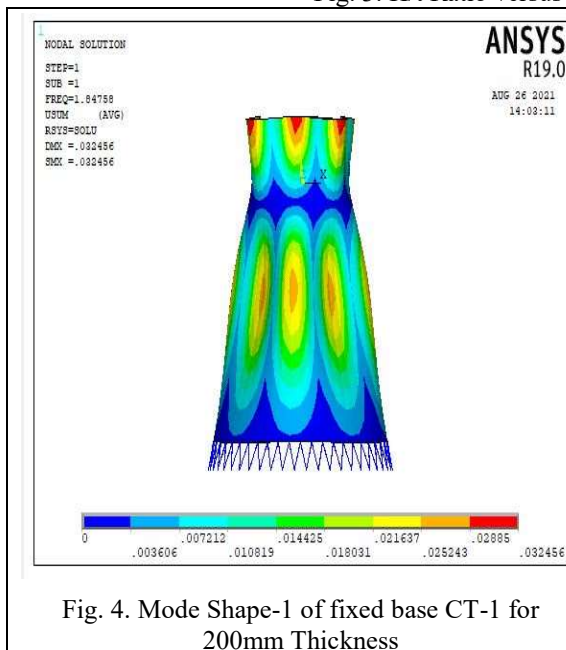

Fig. 4. Mode Shape-1 of fixed base CT-1 for 200mm Thickness

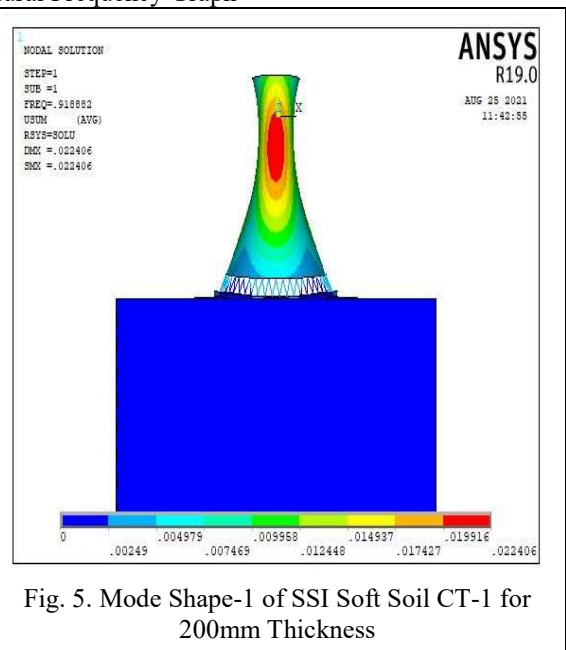

Fig. 5. Mode Shape-1 of SSI Soft Soil CT-1 for 200mm Thickness

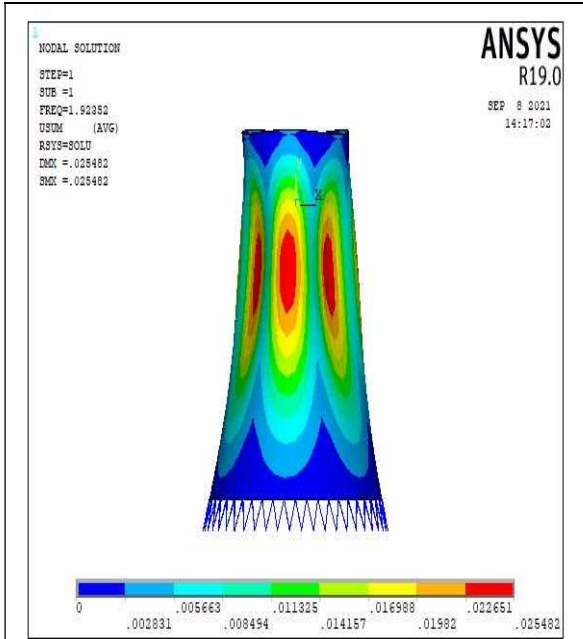

Fig. 6. Mode Shape-1 of fixed base CT-1 for 267mm Thickness

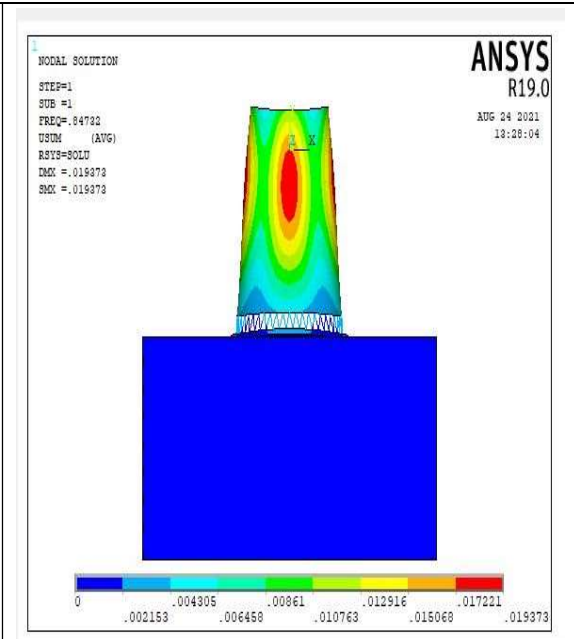

Fig. 7. Mode Shape-1 of SSI Soft Soil CT-1 for 267mm Thickness

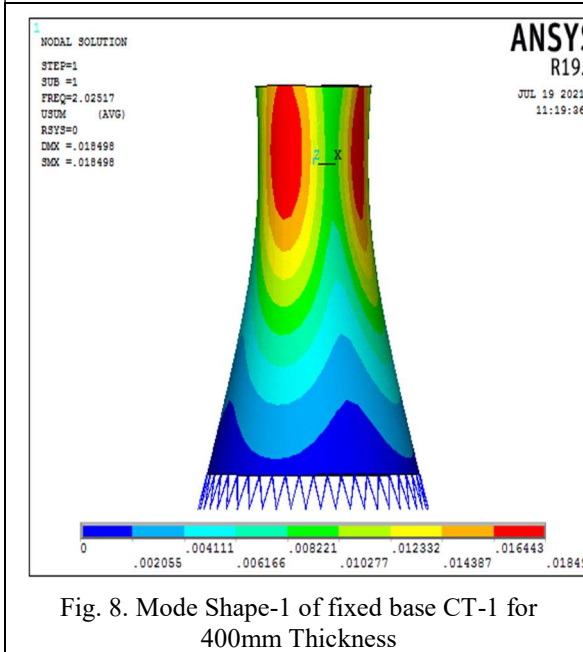

Fig. 8. Mode Shape-1 of fixed base CT-1 for 400mm Thickness

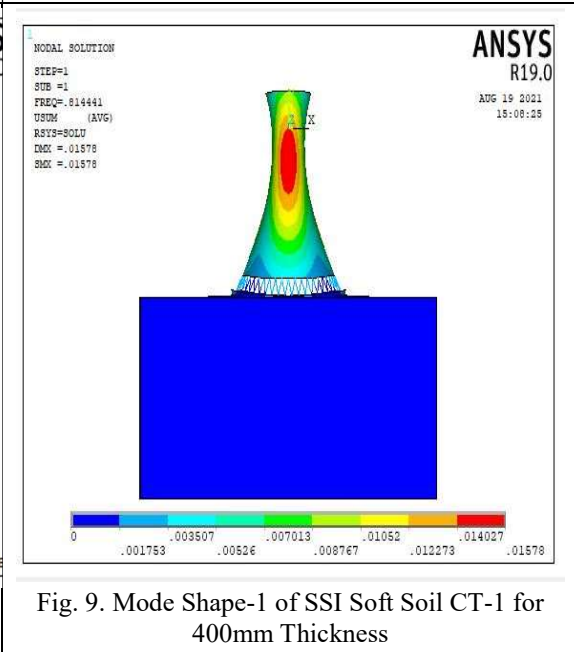

Fig. 9. Mode Shape-1 of SSI Soft Soil CT-1 for 400mm Thickness

3.3. Effect of thickness on maximum displacement

As the thickness of the cooling tower increases for the model's Maximum displacement also increases. Model-1 with a fixed base is having a Maximum displacement of 4.294mm whereas Model-1 with SSI is having 28.754mm for soft soil condition. This is because of considering the Soil spring values for Soil structure interaction.

Table 4. Maximum Displacement values from Response Spectrum Analysis

Model	H/t Ratio	Thickness (mm)	Maximum Displacement(mm)	
			Fixed Boundary Condition	Soil Structure Interaction
CT-1	400	200	4.294	28.754
CT-1	300	267	4.568	32.455
CT-1	200	400	4.778	36.592
CT-2	400	475	24.351	63.545
CT-2	300	634	25.198	69.506
CT-2	200	950	35.497	78.560

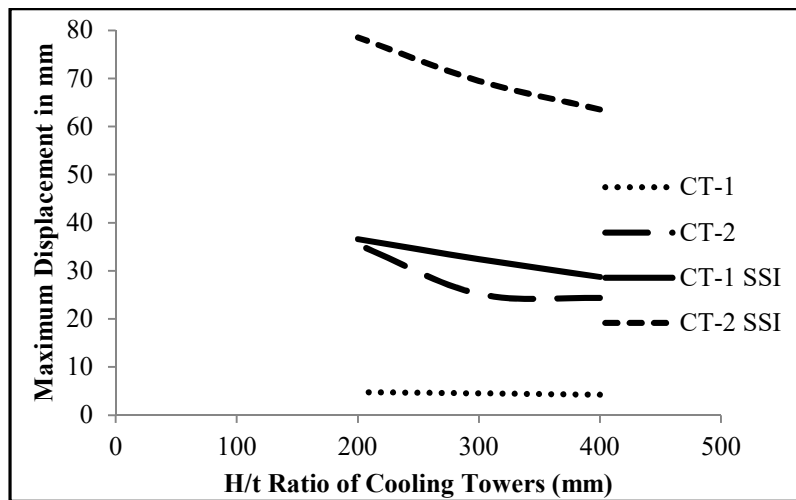

Fig. 10. H/t Ratio versus Maximum Displacement Graph

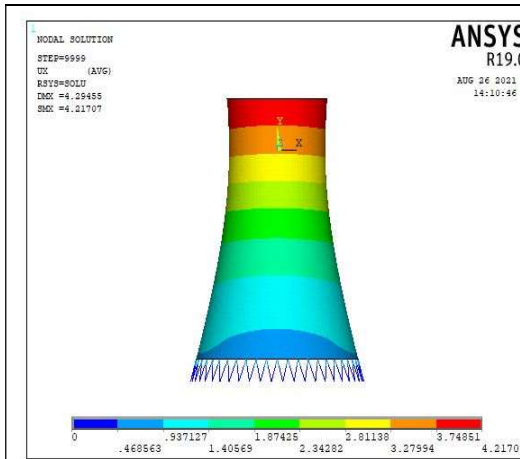

Fig. 11. Maximum Displacement of fixed base CT-1 for 200mm Thickness

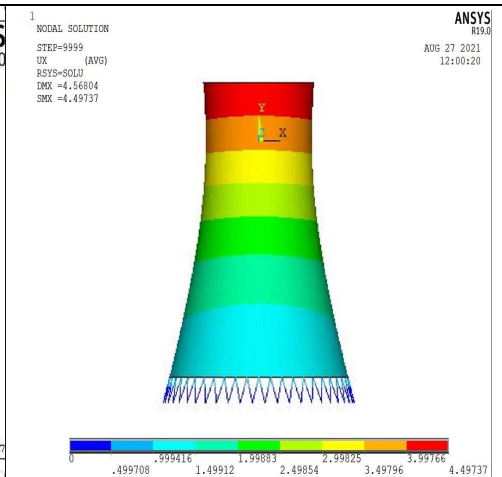

Fig. 12. Maximum Displacement of SSI Soft Soil CT-1 for 200mm Thickness

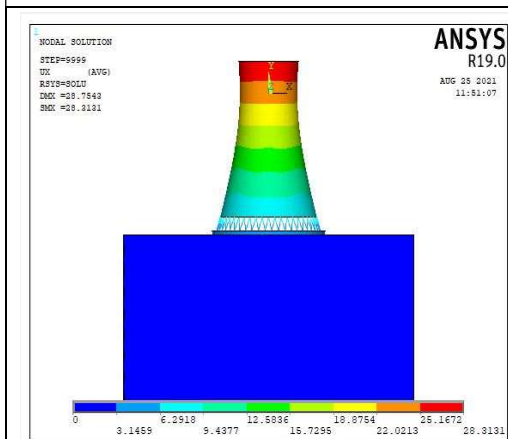

Fig. 13. Maximum Displacement of fixed base CT-1 for 267mm Thickness

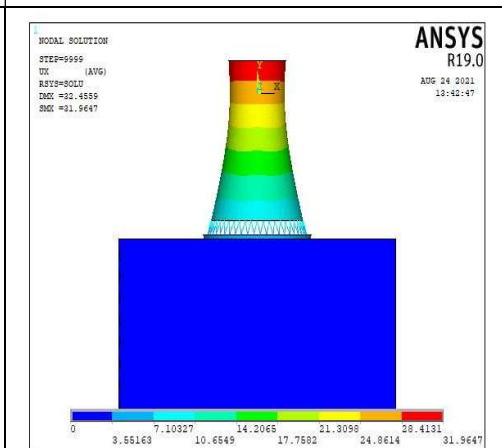
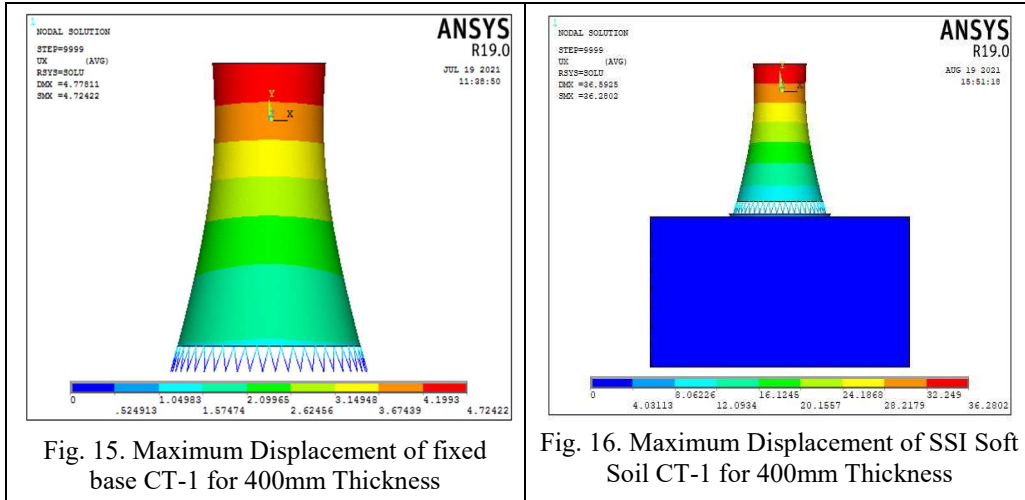

Fig. 14. Maximum Displacement of SSI Soft Soil CT-1 for 267mm Thickness



3.4. Effect of thickness on Maximum Principal Stress

Table 5. Maximum Principal Stress values from Response Spectrum Analysis

Model	H/t Ratio	Thickness (mm)	Maximum Principal Stress (Mpa)	
			Fixed Boundary Condition	Soil Structure Interaction
CT-1	400	200	0.758	0.853
CT-1	300	267	0.834	0.780
CT-1	200	400	0.915	0.690
CT-2	400	475	3.553	2.234
CT-2	300	634	3.407	1.994
CT-2	200	950	3.612	1.776

As the thickness of the cooling tower increases for models Maximum Principal Stress also increases. Model-1 with a fixed base is having Maximum Principal stress of 0.758Mpa whereas Model-1 with SSI is having 0.853Mpa.

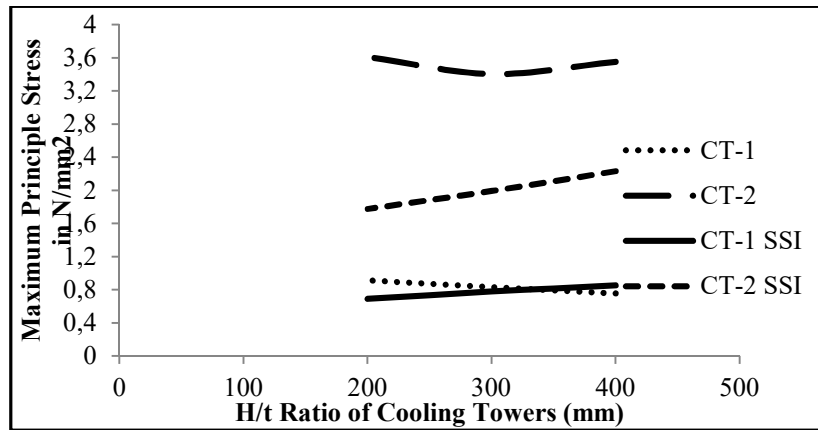

Fig. 17. H/t Ratio versus Maximum Principal Stress Graph

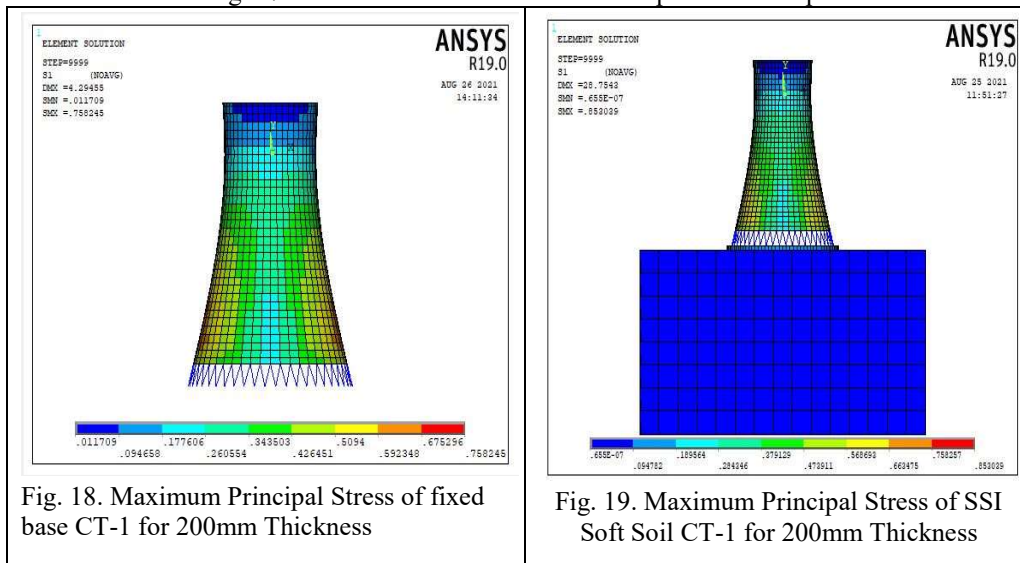

Fig. 18. Maximum Principal Stress of fixed base CT-1 for 200mm Thickness

Fig. 19. Maximum Principal Stress of SSI Soft Soil CT-1 for 200mm Thickness

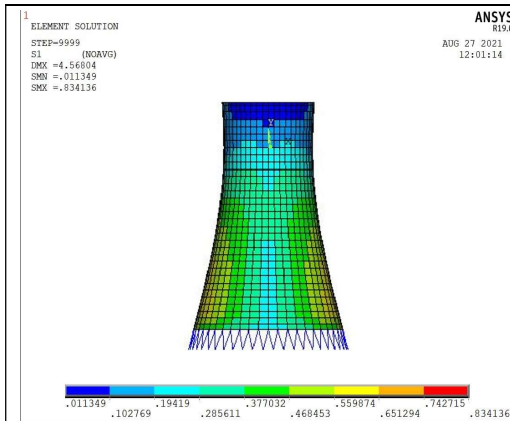

Fig. 20. Maximum Principal Stress of fixed base CT-1 for 267mm Thickness

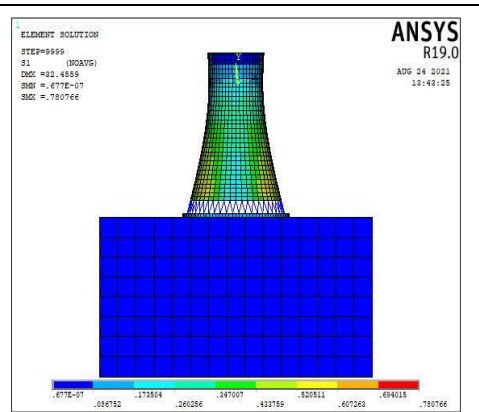

Fig. 21. Maximum Principal Stress of SSI Soft Soil CT-1 for 267mm Thickness

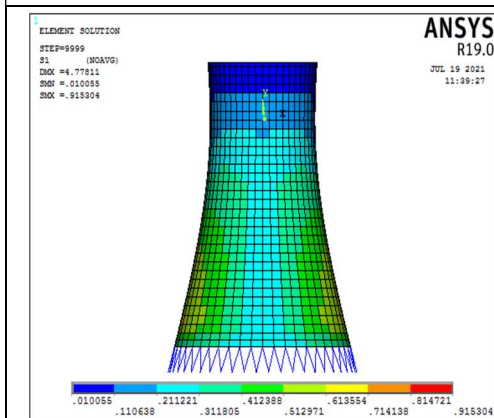

Fig. 22. Maximum Principal Stress of fixed base CT-1 for 400mm Thickness

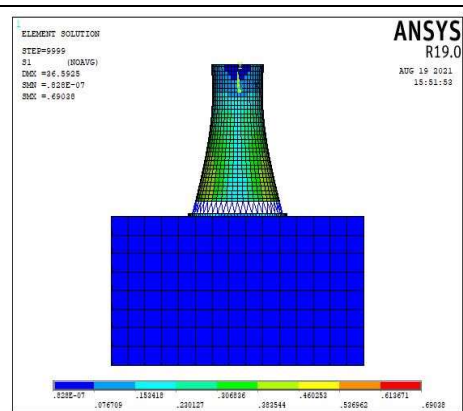

Fig. 23. Maximum Principal Stress of SSI Soft Soil CT-1 for 400mm Thickness

4. CONCLUSIONS

The present work aims at a comparative study on fixed base conditions and soil-structure interaction behavior of natural draft cooling towers. The following conclusions can be drawn from the work

- Since we consider fixed base, Frequency for the fixed base is more, as stiffness increases frequency increases in SSI, fixity will release because of relative stiffness.
- When you compared to fixed base and soil springs, since springs are relatively less stiff because of that there is a rigid body displacement that

will not affect a structure that will not produce any stresses in the structure, hence displacement is more in SSI case.

- Since the soil properties are modeled using a direct approach which will act like an elastic material that undergoes deformation. So, from the study, it is concluded that if wind pressure acting laterally which creates non-uniform upward soil pressure in the foundation which results in settlement of foundation on the lee-ward side of the structure. Because of the difference in the settlement, the structure will tilt, and that results in the deflection at the top level which is a resultant of rigid body rotation.
- Results show that the soil-structure interaction effect significantly modifies the earthquake behavior of Hyperbolic Cooling towers.

REFERENCES

1. Asuman Isil, C 2021. Investigation of behavior of cooling tower structure under external loads. *Cumhuriyet Science Journal*.42,465-475.
2. Saikat Chowdhury, Baibaswata Das, Abhishek Hazra 2020. Behavioural Study of R/C Natural Draught Cooling Tower under Gravity Load using Different Support Orientations. *International Journal of Engineering and Advanced Technology (IJEAT)* **10**, 188-193.
3. Yang, TY and Rakesh Kapania, K 1984. Finite element random response analysis of cooling tower. *Journal of Engineering Mechanics* **10**, 589-609.
4. Mahesh Kumar, CL, Shanthappa, BC, Manjunatha, K 2021. A Study on Dynamic Response of Hyperbolic Cooling Tower for Fixed Base Condition. In: T.G. Sitharam, Raghuvveer Rao Pallegati, Sreevalsa Kolathayar(Eds.) *Seismic Design and Performance. Lecture Notes in Civil Engineering* **120**. Springer, Singapore, 269-275.
5. Prabhakar, N 1990 *Structural design aspects of hyperbolic cooling towers*. Technical Session IV, National Seminar on Cooling towers. Chennai, **9**, 65-72.
6. Ali Naghshineh, Erfan Alavi, Mohammad Reza, Rezaee 2012. *Seismic Behavior of column-supported and Innovative Fixed-base Cooling Towers with Ring Beam*. In: Proceedings of the 15th World Conference on Earthquake Engineering, NITK Surathkal.
7. Dieter Busch, Reinhard Harte, Wilfried, B, Kratzig and Ulrich Montag. 2002. New natural draft cooling tower of 200 m of height. *Engineering Structures*. **24**, 1509-1521.
8. Chiranjit Mishra, Ranjith, A , Sanjith, J and Kiran, BM 2015. Wind Induced Interference Effects on Natural Draught Cooling Tower. *International Journal of Progresses in Civil Engineering (IJPCE)* **2**, 6-12.

9. Tejas, G, Gaikwad, Gore, NG, Sayagavi, Kiran Madhavi, VG, Sandeep 2014. Effect of Wind Loading on Natural Draught Cooling Tower. *IJEAT* **4**, 34-39.
10. Murali, G, Vivek Vardhan, CM, Prasanth Kumar Reddy, BV 2012. Response of Cooling Towers to Wind Loads. *ARPJ Journal of Engineering and Applied Sciences* **7**, 114-120.
11. Augusti, G, Borri, C and Zahlten, W 1991. *Nonlinear Dynamic Analysis of Cooling Towers under Stochastic Wind Loading*. In: Nonlinear Stochastic Mechanics, IUTAM Symposium, Turin, 25-34.
12. Li, Long-yuan and Loo, Wen-da 1989. Nonlinear Buckling Analysis of Hyperbolic Cooling Tower Shell With Ring-Stiffeners. *Applied Mathematics and Mechanics* **10**, 113-118.
13. Mohan Babu, T, Khasim, Khan, Nema, MK and Raghavan, N 2004. *A comparative study of wind dynamic effects on NDCTs as per various international standards*. In: Proceedings of the Fifth International Symposium on Natural Draught Cooling Towers. Istanbul, Turkey.
14. Poddar, K 2007 *National Wind Tunnel Facility at IIT Kanpur Overview*. In: Proceedings of the National Conference on Wind Tunnel Testing. IIT Kanpur.
15. Shitang, Ke, Wei, Yu, Peng, Zhua, Yaojun, Ge and Xian'an, Hou 2018 Full-scale measurements and damping ratio properties of cooling towers with typical heights and configurations. *Thin-Walled Structures* **124**, 437-448.
16. Selvi Rajan, S, Ramesh Babu, G, Arunachalam, S, Nagesh, R. Iyer and Lakshmanan, N 2013. *Interference Factors For Natural Draught Cooling Towers Based On Wind Tunnel Experiments* In: The Eighth Asia-Pacific Conference on Wind Engineering, Chennai, India. 490-498.
17. Mahesh Kumar, CL, Shwetha, KG, Shanthappa, BC and Manjunatha, K 2021 Effect of Buckling Due to Wind Load on Analysis of Natural Draught Cooling Tower. In: Nandagiri L., Narasimhan M.C., Marathe S., Dinesh S. (eds) *Sustainability Trends and Challenges in Civil Engineering. Lecture Notes in Civil Engineering* **162**, Springer, Singapore, 1077-1093.
18. IS 1893 (Part 1) – 2016, *Criteria for Earthquake Resistant Design of Structures*, Bureau of Indian Standards, New Delhi.
19. Yang, TY and Rakesh, KK 1983. Shell Elements for Cooling Tower Analysis. *J. Eng. Mech.* **109**, 1270-1289.
20. IS:11504-1985, *Criteria for Structural Design of Reinforced Concrete Natural Draught Cooling Towers*, Bureau of Indian Standards, New Delhi, 1985.

Editor received the manuscript: 10.09.2021